

Kippenhok Eva



Benodigheden:

- Schroefmachine
- Rolmaat
- Bit pz2
- Bit pz1
- Boortje 4mm (is meegeleverd)
- *ALLE SCHROEVEN VOORBOREN*



1x



1x



2x



2x

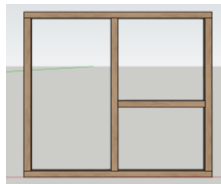

1x

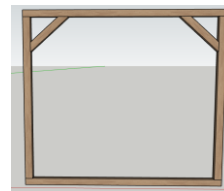

2x

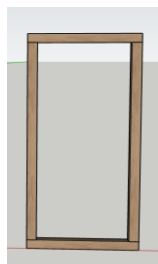

1x



7x

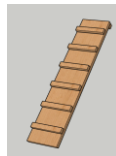

1x



1x

Dakbedekking
-3x 352x45cm



Rabat

-3x 79cm - 30° -30°
-3x 48cm - 30° -30°

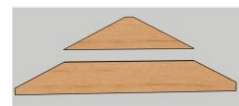

Lat

-2x 71,4cm (30x16mm)
-2x 34cm (65x16mm)
-4x daktrim 60cm



Balk 44x44mm

-4x 79cm
-1x 57cm
-14x 51,6cm - 30° - 60°

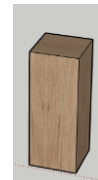

Overige

-4x Geheng 20cm
-2x schuifslot

-44x Schroef 70mm
-50x Schroef 40mm
-102x Schroef 30mm
-16x Schroef 20mm

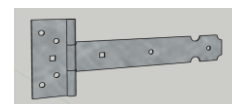
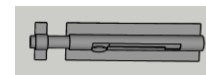

1.

2x Lat 30x16mm - 2x 71,4cm
6x Schroef 30mm

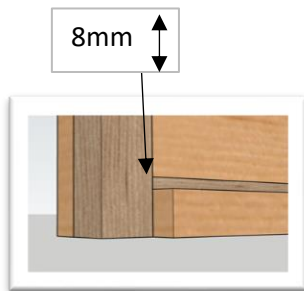

2.

3x Schroef 70mm



Onder/bovenaanzicht

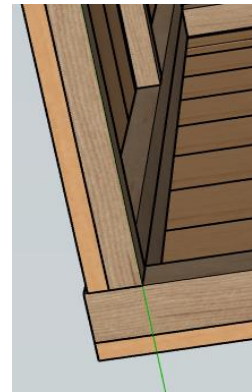

3.

3x Schroef 70mm



4.

3x Schroef 70mm



5.

3x Schroef 70mm

Onder/bovenaanzicht

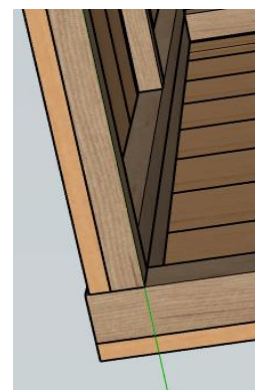

6.

3x Schroef 70mm

Onder/bovenaanzicht

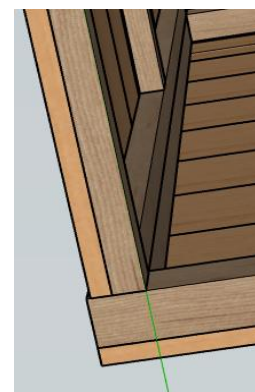
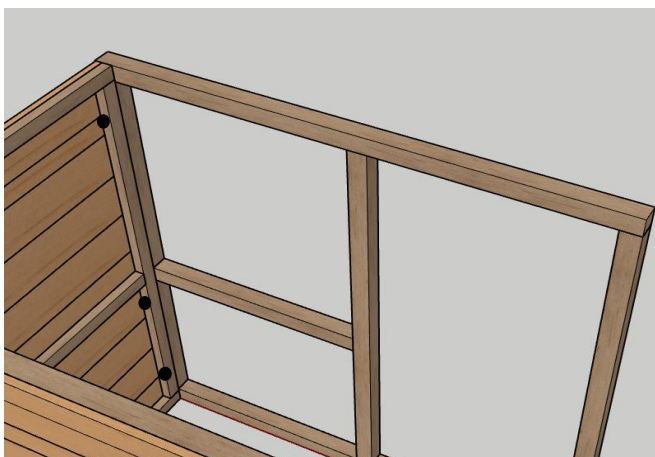

7.

4x Schroef 70mm

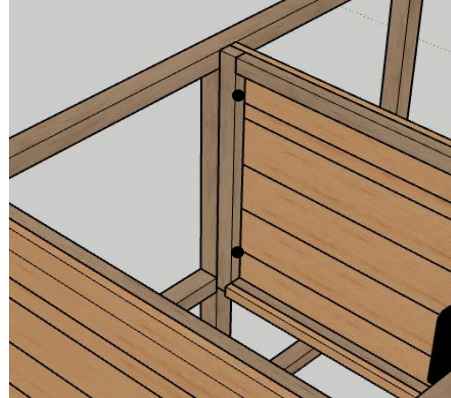
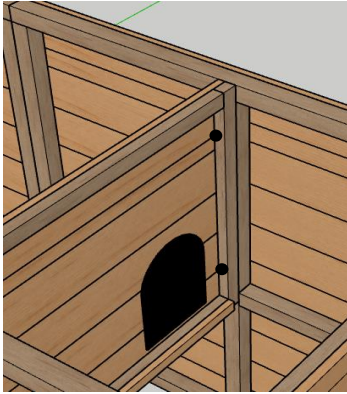

8.

3x Schroef 70mm



9.

6x Schroef 70mm

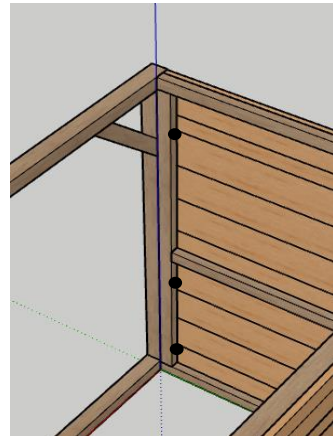

10.

1x betonplex 55x85cm

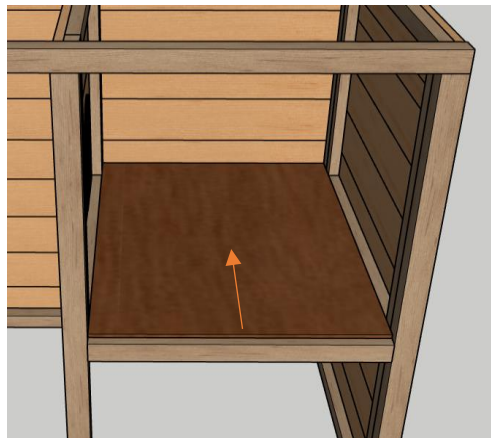

11.

4x geheng 20cm
12x Schroef 30mm

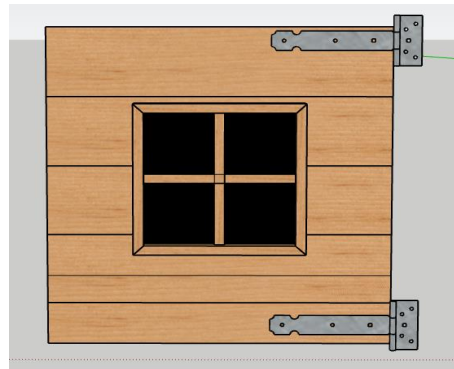
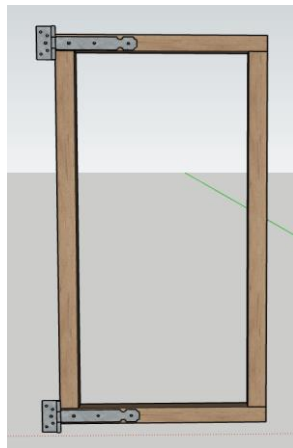

12.

2x Schuifslot
8x Schroef 40mm
16x Schroef 20mm



13.

2x Lat 65x16mm - 34cm
1x Balk 44x44mm - 57cm
1x Legbak
12x Schroef 30mm

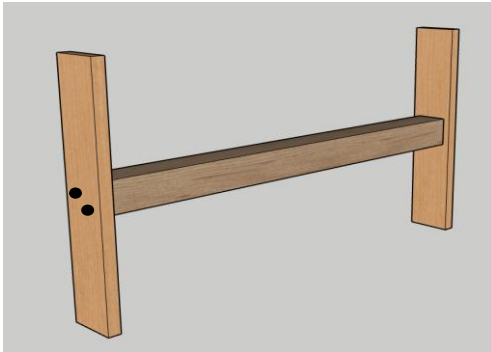

1.



2.

14.

4x Balk 44x44mm - 79cm
16x Schroef 70mm

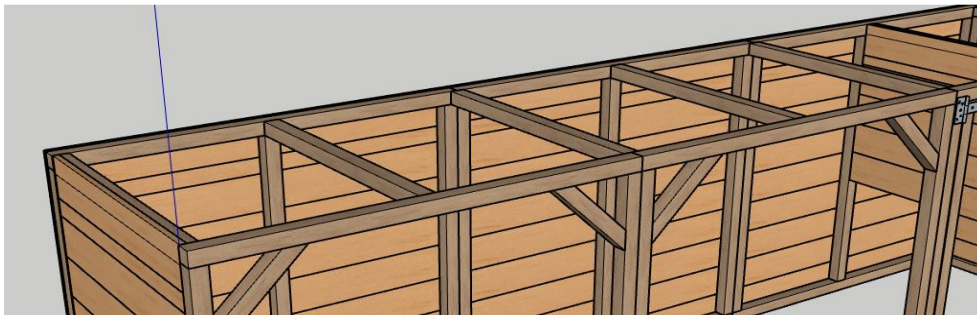

15.

14x Balk 44x44mm - 51,6cm 30* - 60*
42x Schroef 40mm

1.

19mm ↔

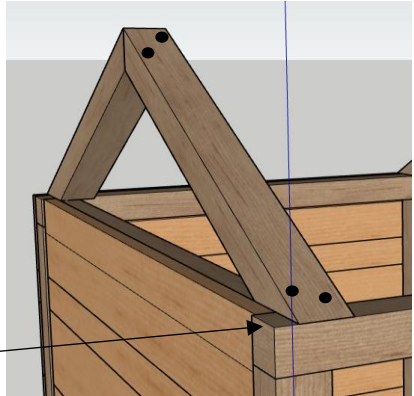

2.

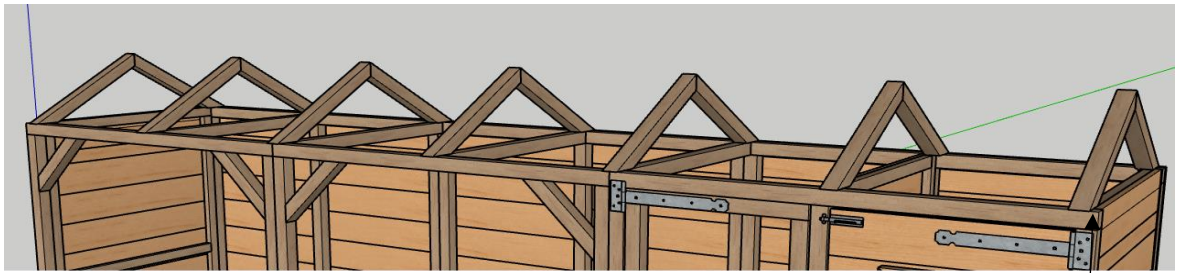

19mm ↔

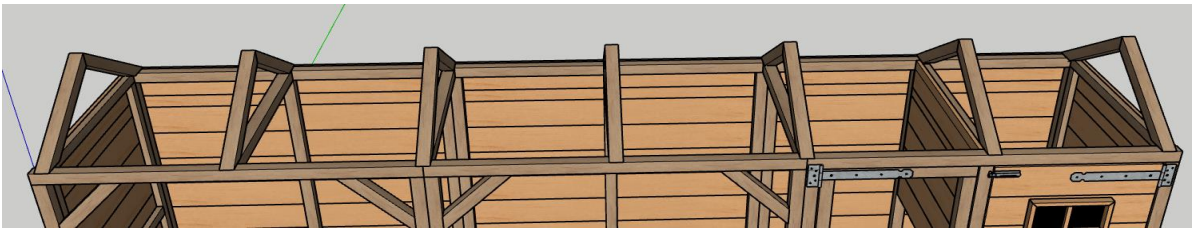

16.

3x Rabat 79cm - 30* -30*
3x Rabat 48cm - 30* -30*

1.

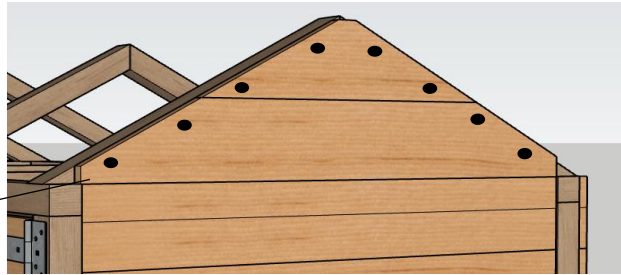

2.



17.

4x Betonplex 116x55cm
2x Betonplex 120x55cm
32x Schroef 30mm

22mm ↔

22mm ↔



18.

3x dakbedekking 352x45cm



Verwijder de folie van de onderzijde en verdeel hierna de dakbedekking over de betonplex platen.



11cm



1.



2.

19.

4x Daktrim 60cm
16x Schroef 30mm

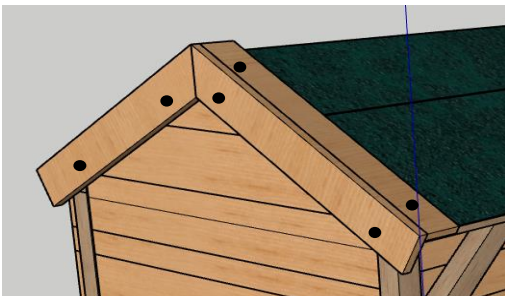

Legnest

1.

Verwijder twee planken aan de kopzijde

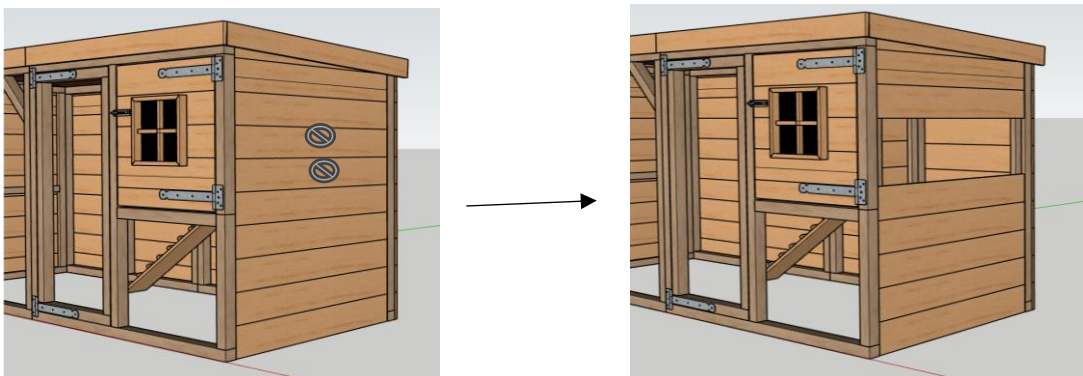

2.

4x schroef 60mm

